

Installation Information

Como Roller Blind

Parts Included

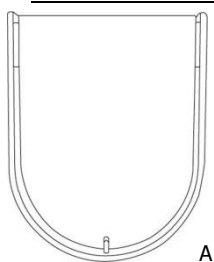

Bracket Covers
(Outside Mount Only)
Qty: 2

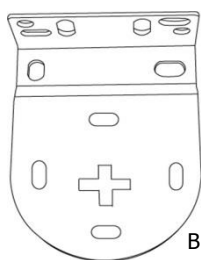

Control Bracket
Qty: 1

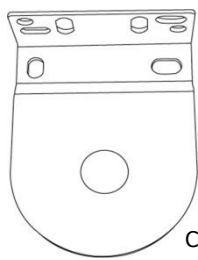

Idle Bracket
Qty: 1



Installation
Screws
Qty: 6

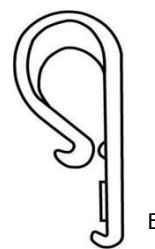

Child Safety
Device
Qty: 1



Safety
Screws
Qty: 2

Important Notes

- Please check that all parts have been supplied before you begin to assemble your new Custom Roller Blind
- Do not unroll the blind until it is fully installed
- The finished blind width is from the outside of the left bracket to the outside of the right bracket
- Ensure that the blind is mounted level for correct operation

Positioning Blind

As per your order, determine the correct fitting location of mounting brackets and mark where you are going to install the brackets.

- i) Inside the window frame (Inside Mount) or;
- ii) On the window frame or wall (Outside Mount)

Installing Mounting Brackets

- i) Place the Control Bracket (part B) in the desired location, as per your order i.e. on the LHS or RHS, mark and if necessary pre drill 2 holes. After drilling the holes, secure the bracket with screws (part D). (Wood screws have been provided, however screws suitable for gyprock or brick walls may need to be purchased)
- ii) Repeat this process for the Idle Bracket (part C)

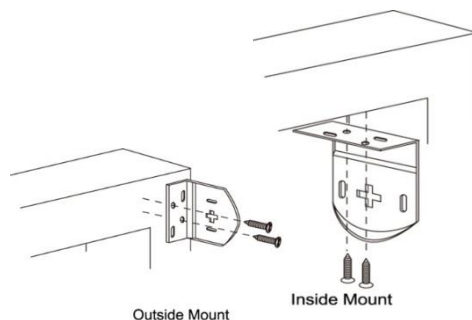

Attaching Blind to Brackets

- i) Insert the idle mechanism into the idle bracket (part C) so it is engaged (Figure 1)
- ii) Carefully align the chain control mechanism with the control bracket (part B) (Figure 2) (this is the one with the cross). Push the blind into the control bracket, ensuring the chain is hanging directly down. Hook into place with a gentle downward motion

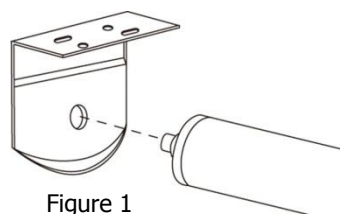

Figure 1

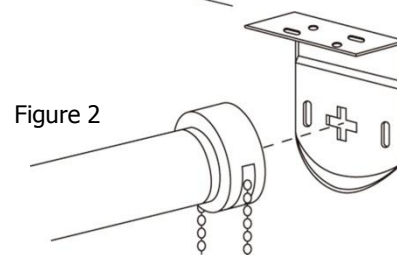

Figure 2

Bracket Covers

Install the bracket covers supplied for any outside mount blinds.

Operating the Blind

Using the chain, draw the blind up and down several times to ensure the blind operates correctly.

Attaching Child Safety Device (For more safety information, please see over page)

Secure the child safety device (part E) to the wall beside the blind, ensuring the chain is not too tight, as this may restrict smooth operation.

Installation Information

Como Roller Safety Information

Child Safety Instructions *For Blinds With Chain Control*

Warning

- The chain tension device must be fitted to ensure child safety
- The chain tension device is to be positioned at the bottom of the chain loop
- It can be fitted to the inside of the reveal (Frame) or in front of the reveal (Frame)



Child Safety Device

Fitting Instructions

1. Position the tension device at the bottom of the chain loop (Figure 1)
2. Install the tension device onto the reveal/frame, making sure that the loop chain hangs with minimal tension (Figure 2)

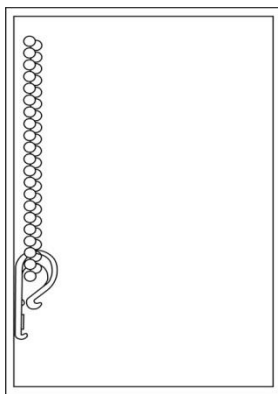

Figure 1

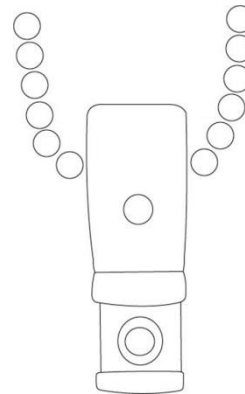

Figure 2



WARNING – ALL WINDOW COVERINGS WITH CORD OR CHAIN

To avoid creating a possible strangulation hazard for children, the corded or chained internal window covering must be installed in such a way that a loose cord or chain cannot form a loop 220mm or longer at a height of less than 1600mm above floor level.

- A cord/chain guide may be installed lower than 1600mm above floor level if the cord/chain is sufficiently secured or tensioned to prevent a loop 220mm or longer being formed
- If a cord/chain guide is installed lower than 1600mm above floor level, it must be designed to prevent a child from being able to remove the cord/chain
- If a cleat is used to secure the cord, it must be at least 1600mm above floor level because a child is capable of unwinding a cord from a cleat